

Quality • Reliability
Cost-Down via Innovation

ESM

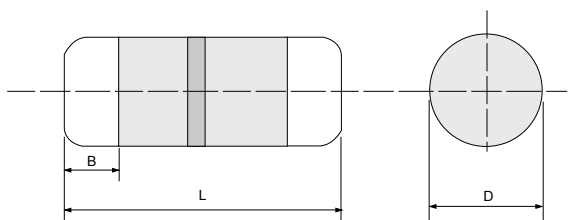

Features

- Protects through sparking over the porous layer when surge exceeds the spark-over voltage
- Patented construction with reduced costs
- High insulation resistance, low capacitance, and fast response time
- RoHS and REACH compliant

Applications

- Human body model ESD protection
- Telephone/Fax Machine/Modem Protection
- Signal Line Protection
- USB protection
- Ethernet protection
- Low voltage power protection
- Support products to comply with IEC61000-4-2, ISO10605 requirements, etc.

■ DIMENSIONS

Type	Body Length (L, mm)	Cap Diameter (D1, mm)	Body Diameter (D2, mm)	Soldering Spot (B, mm)	Net Weight Per 1000 pcs
ESM204	3.52 ± 0.15	1.35 ± 0.1	D1+0.02/-0.15	0.6 Min.	17 grams

Cross-Section View

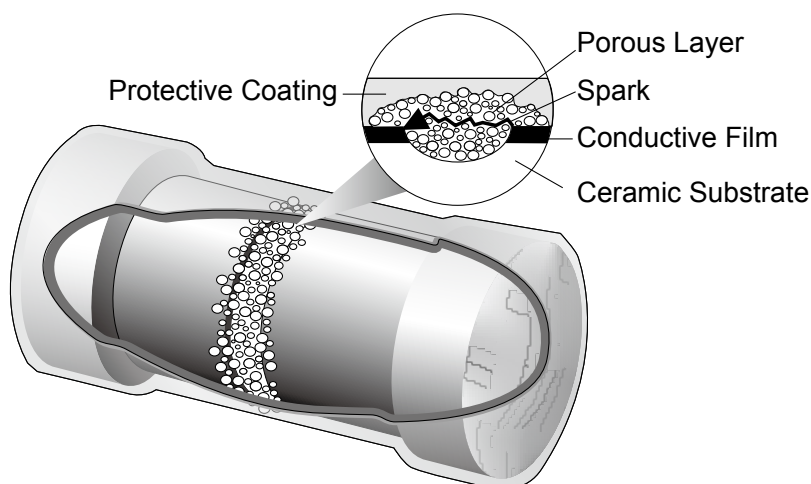

Legal disclaimer: This international patent is covered by Paris Convention for the Protection of Industrial Property under World Intellectual Property Organization (WIPO). Plagiarism and imitation shall be severely punished.

■ GENERAL SPECIFICATIONS

Series	Type Name	Color Code	DC spark-over voltage
ESM	ESM204	White	1300V ± 30%

Special sizes, values, and specifications not listed available on special order.

■ PART NUMBER

Example: ESM204N1300XXXTR3K0

ESM204	N	1300	XXX	TR3K0
Type	Tolerance	Spark-Over Voltage	TCR	Packaging
	N (30%)	1300V 4-character code	3-character code Parameter Not Applicable	5-character code TR = Tape Reel (pieces per reel) 3K0 = 3,000 6K0 = 6,000* 10K = 10,000*

*upon request

■ TECHNICAL SUMMARY

Characteristics	Limits
Dielectric Withstanding Voltage, VAC or DC	500
Surge Current Capacity	60A @8/20µs (80A @2/10µs)
Operating Temperature Range, °C	-55 ~ +155
Insulation Resistance, MΩ (Measured with DC 500V)	> 100
Capacitance	≤ 1pF
Activation time	≤ 1ns

■ PERFORMANCE SPECIFICATIONS

Characteristics	Test Conditions	Limits
Resistance To Soldering Heat	IEC 60115-1 4.18.2 Dip the resistor into a solder bath measured (260±5)°C and hold it for a 10±1 seconds	Rated value 40%
Solderability	IEC 60115-1 4.17.2 Solder area covered after (235±3)°C/(2±0.2) seconds with flux applied	95% min.coverage
Vibration	IEC 60115-1 4.22 Six hours in each parallel and axial direction with a simple harmonic motion having an amplitude of 1.52mm and 10 to 2,000 Hz.	Rated values still satisfied
Thermal Endurance	IEC 60115-1 4.25.3 1000 hours at 155°C without load	Rated value 40%
Thermal Shock	IEC 60115-1 4.19 -55°C 30minutes, +155°C 30minutes, 5 cycles	Rated value 40%
Surge Life	3000pF/ 10KV/ 0ohm, times = 300	No function failure

■ SUGGESTED PAD LAYOUT

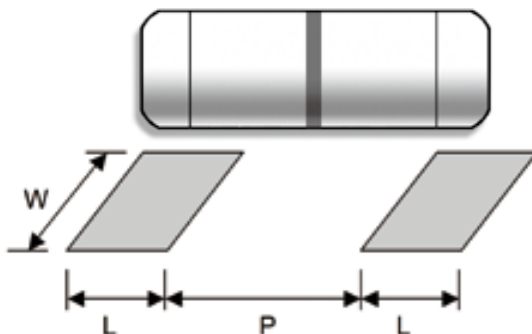

Type	Soldering mode	Pad Length (L, mm, min.)	Pad Spacing (P, mm)	Pad Width (W, mm, min.)
ESM204	Reflow	1.3	1.6 ± 0.1	1.6
	Wave	1.5	1.5 ± 0.1	1.8

For better heat dissipation / lower heat resistance, increase W & L.

■ COVER TAPE PEELING SPECIFICATION

Recommended peeling force:

ESM204: 50±5gf

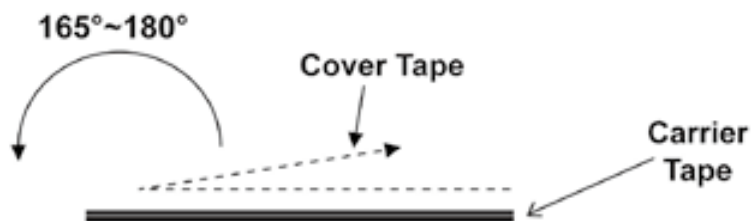

Quality • Reliability
Cost-Down via Innovation

ESM

■ APPLICATIONS

Telephone/Fax Machine/Modem/USB/Mouse/Ethernet/Low-voltage power Protection (common-mode protection)

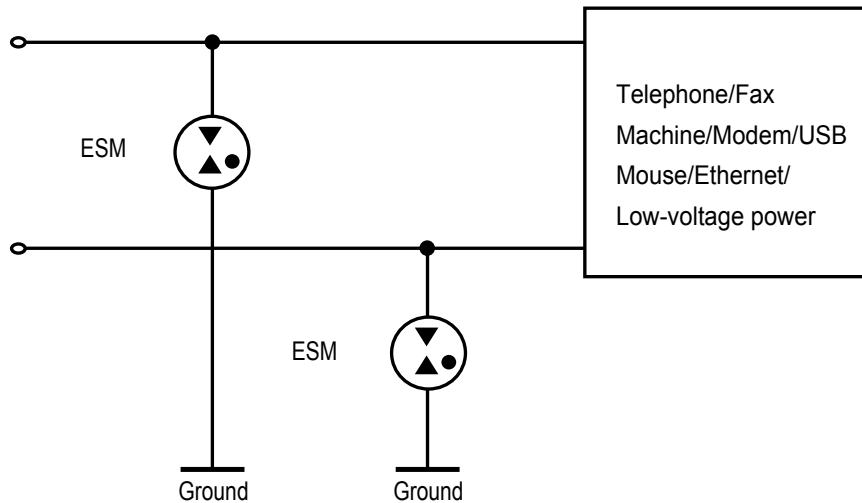

These ESM absorbers protect against common-mode interference voltages, i.e. surge voltages that appear in both exchange lines connecting to the ground. In the event of voltage overload, the ESM protects both exchange lines by conducting the surge current away to the ground.

Signal Line Protection (differential-mode protection)

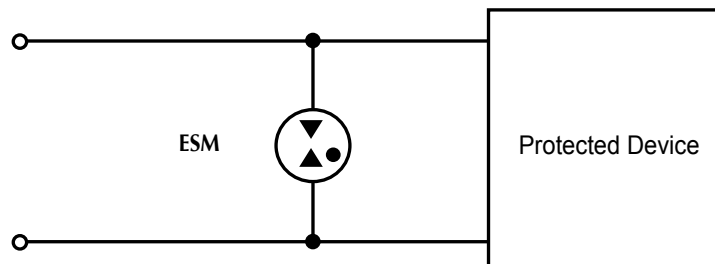

Signal circuits often run with no ground conductor. A ESM circuit located between the two signal lines offers differential mode protection by preventing the occurrence of large potential difference at the input of the equipment to be protected

Series of ESD Surge MELF Absorber (ESM) and Metal-Oxide Varistor (MOV)

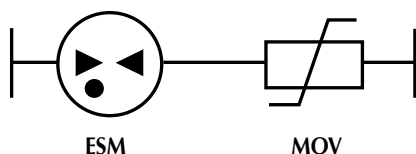

Benefits:

1. Capacitance of this branch circuit would be reduced to pF level.
2. MOV has almost no current leakage.
3. MOV aging-related issue would be greatly improved,, increasing reliability of the circuit.